

35L6-GT

BEAM PENTODE

DESCRIPTION AND RATING

The 35L6-GT is a beam pentode primarily designed for use in the audio frequency power output stage of radio receivers. Features include high power sensitivity and high efficiency at relatively low plate and screen voltages.

GENERAL

ELECTRICAL

Cathode—Coated Unipotential
 Heater Voltage, AC or DC 35.0 Volts
 Heater Current 0.15 Amperes

MECHANICAL

Mounting Position—Any
 Envelope—T-9, Glass
 Base—B6-81 or B7-7, Intermediate-Shell Octal 6- or 7-Pin
 or B6-84 or B7-47, Short Intermediate-Shell Octal 6- or 7-Pin

MAXIMUM RATINGS

DESIGN-CENTER VALUES

Plate Voltage	200	Volts
Screen Voltage	125	Volts
Plate Dissipation	8.5	Watts
Screen Dissipation	1.0	Watts
Heater-Cathode Voltage		
Heater Positive with Respect to Cathode	90	Volts
Heater Negative with Respect to Cathode	90	Volts
Grid-Number 1 Circuit Resistance		
With Fixed Bias	0.1	Megohms
With Cathode Bias	0.5	Megohms

CHARACTERISTICS AND TYPICAL OPERATION

CLASS A₁ AMPLIFIER

Plate Voltage	110	200	Volts
Screen Voltage	110	125	Volts
Grid-Number 1 Voltage	-7.5	Volts
Cathode-Bias Resistor	180	Ohms
Peak AF Grid-Number 1 Voltage	7.5	8.0	Volts
Plate Resistance, approximate	14000	34000	Ohms
Transconductance	5800	6100	Micromhos
Zero-Signal Plate Current	40	43	Milliamperes
Maximum-Signal Plate Current	41	43	Milliamperes
Zero-Signal Screen Current	3.0	2.0	Milliamperes
Maximum-Signal Screen Current	7.0	5.5	Milliamperes
Load Resistance	2500	5000	Ohms
Total Harmonic Distortion, approximate	10	10	Percent
Maximum-Signal Power Output	1.5	3.0	Watts

BASING DIAGRAM

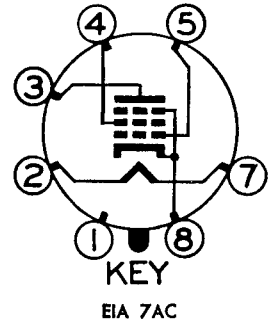

TERMINAL CONNECTIONS

- Pin 1—No Connection
 - Pin 2—Heater
 - Pin 3—Plate
 - Pin 4—Grid Number 2 (Screen)
 - Pin 5—Grid Number 1
 - Pin 7—Heater
 - Pin 8—Cathode and Beam Plates
- Note: Pin 1 omitted on bases B6-81 and B6-84

PHYSICAL DIMENSIONS

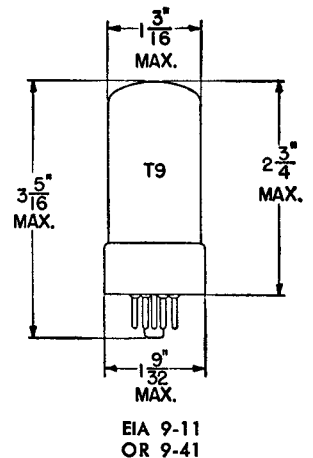

AVERAGE PLATE CHARACTERISTICS

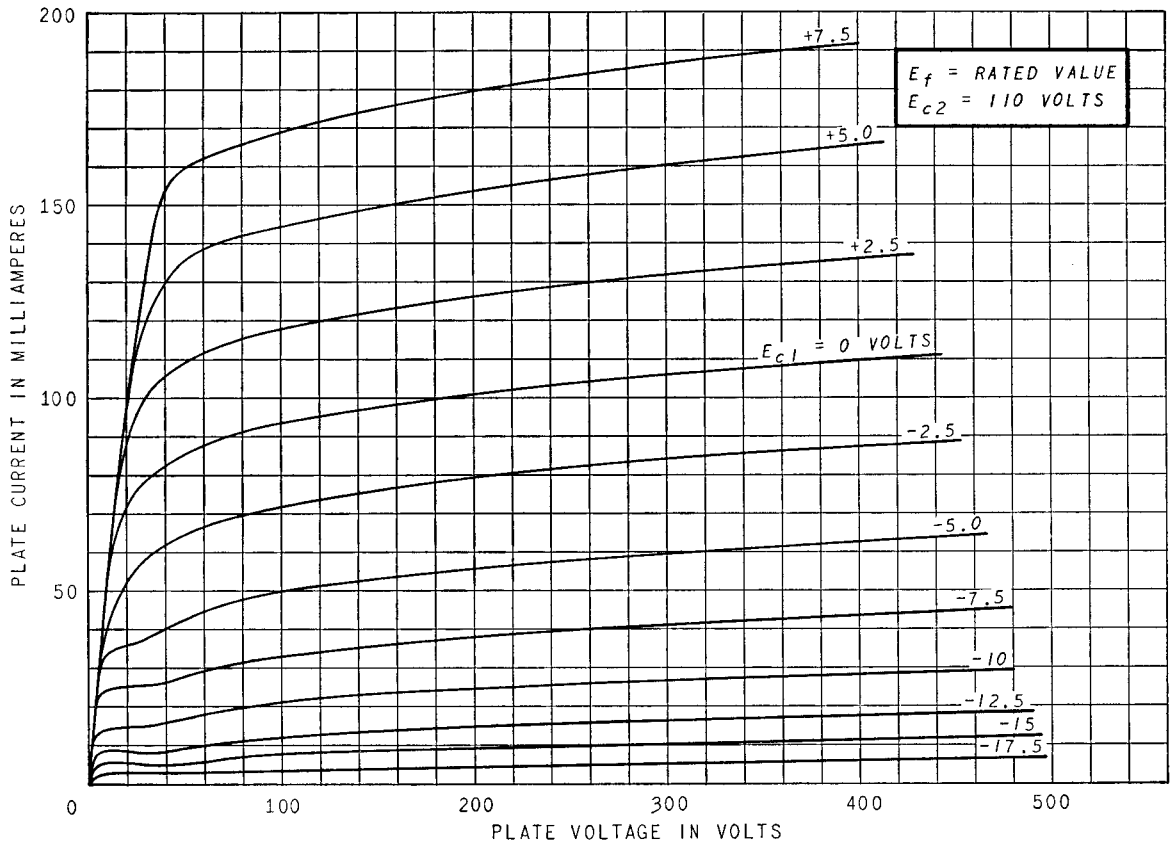

AVERAGE PLATE CHARACTERISTICS

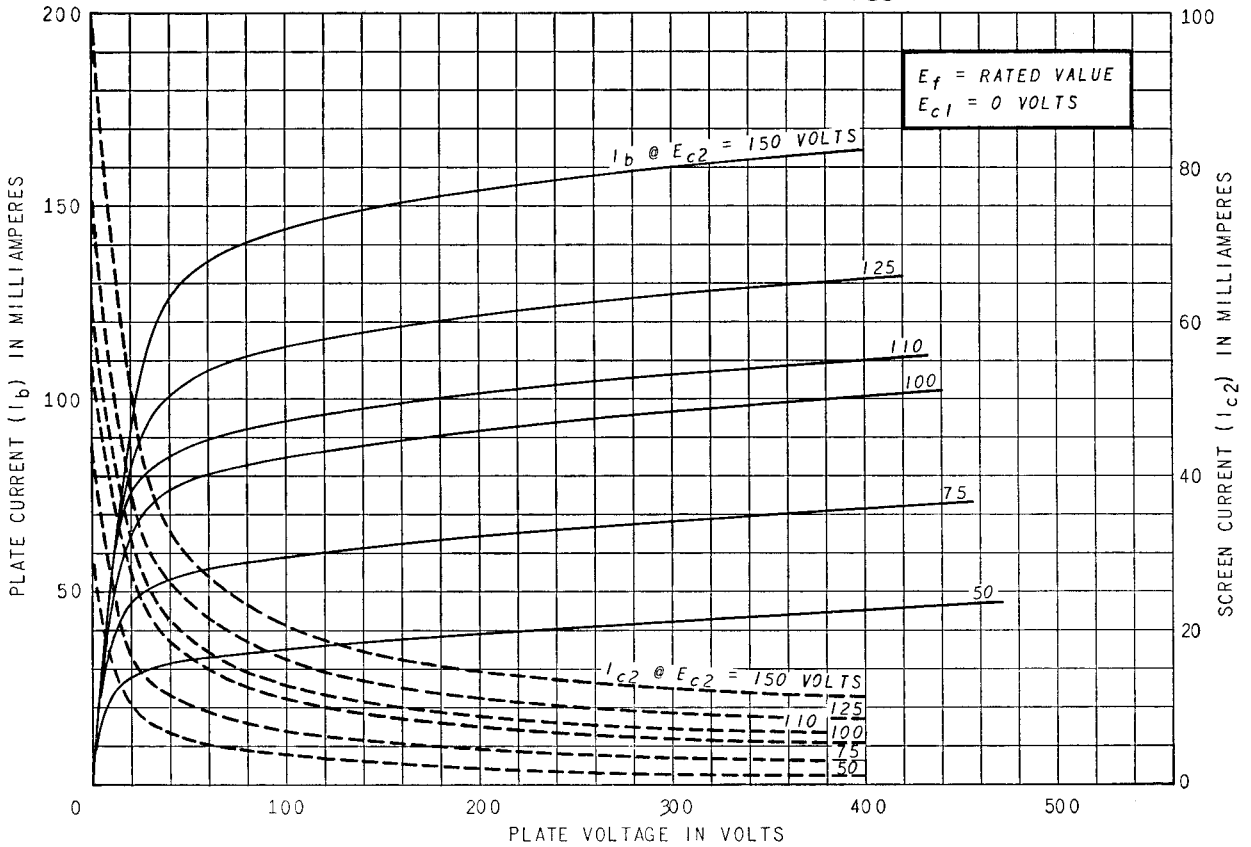

AVERAGE CHARACTERISTICS

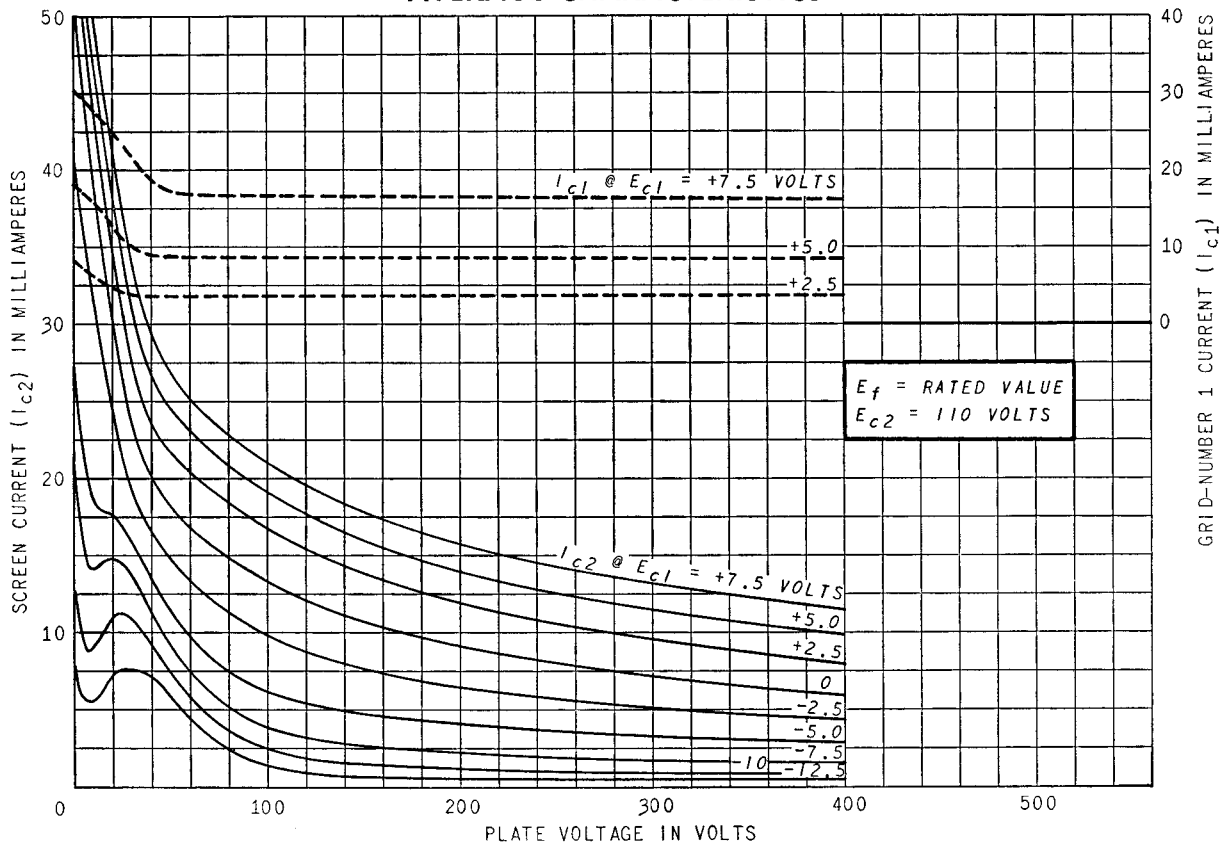

OPERATION CHARACTERISTICS

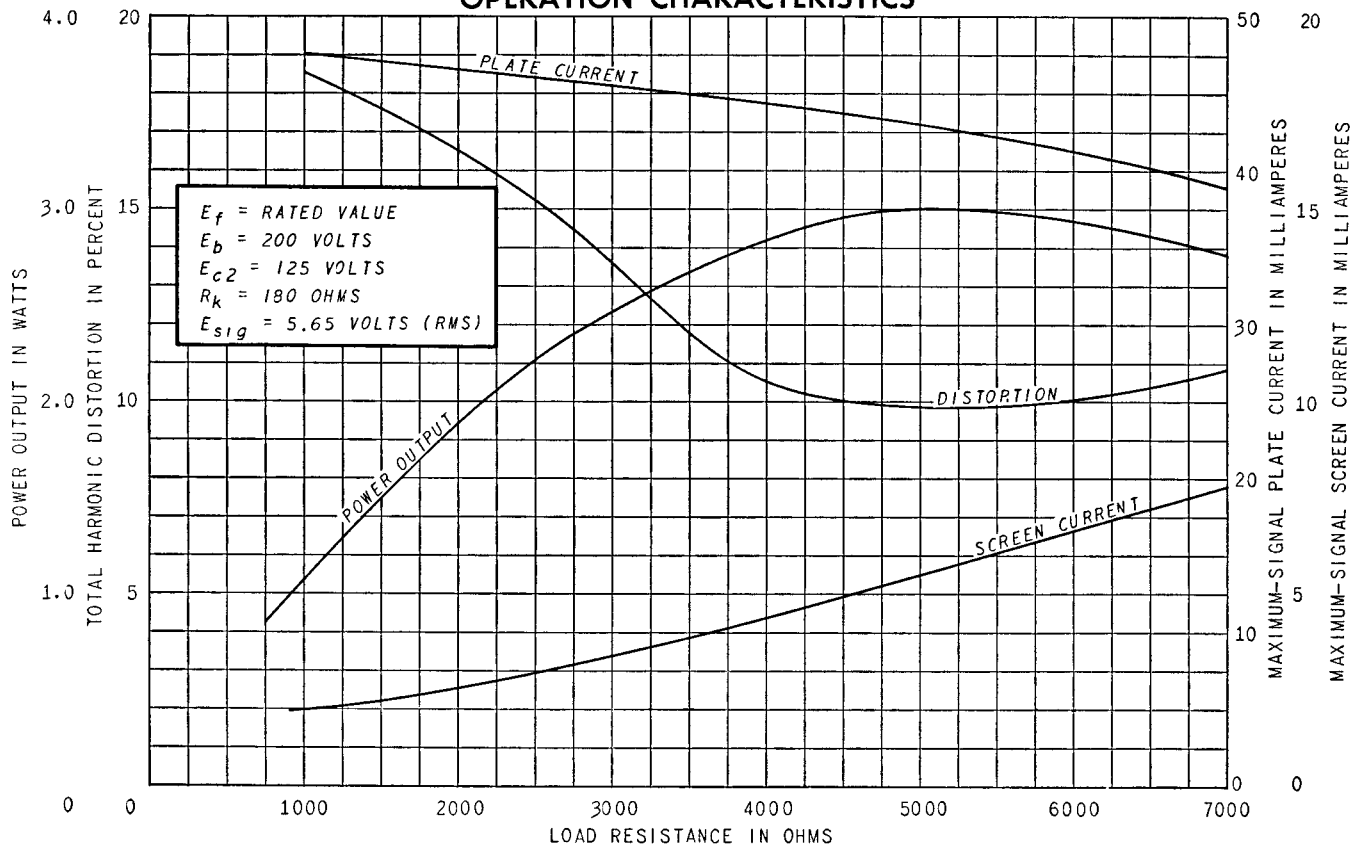

AVERAGE TRANSFER CHARACTERISTICS

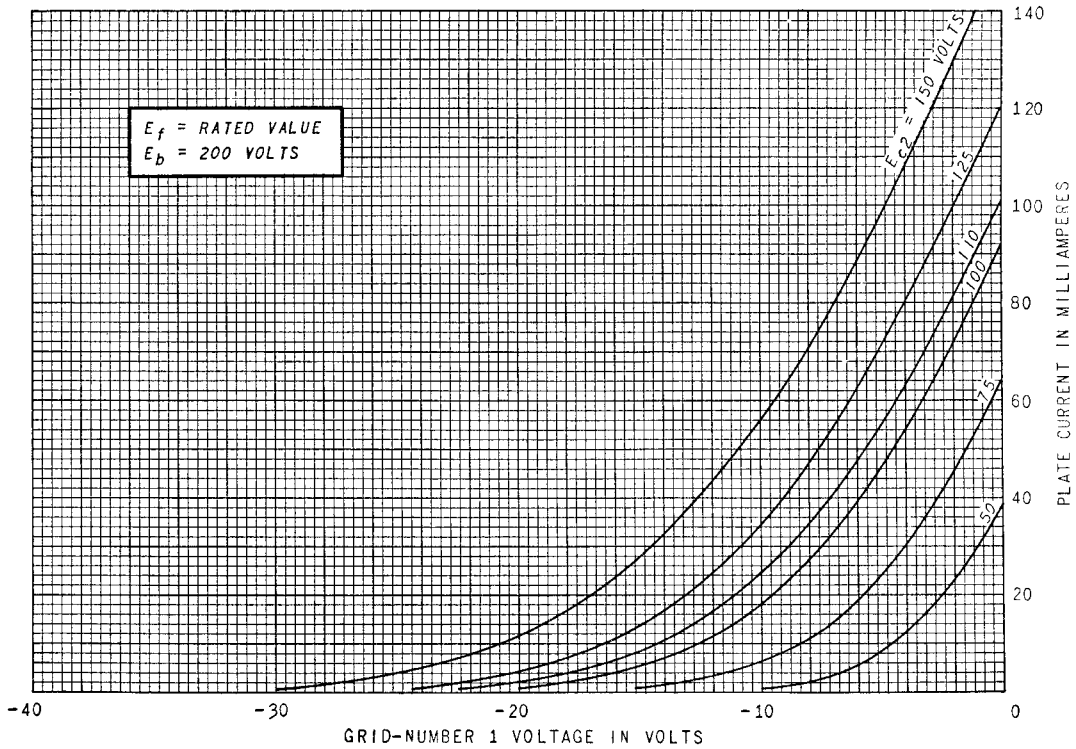

AVERAGE TRANSFER CHARACTERISTICS

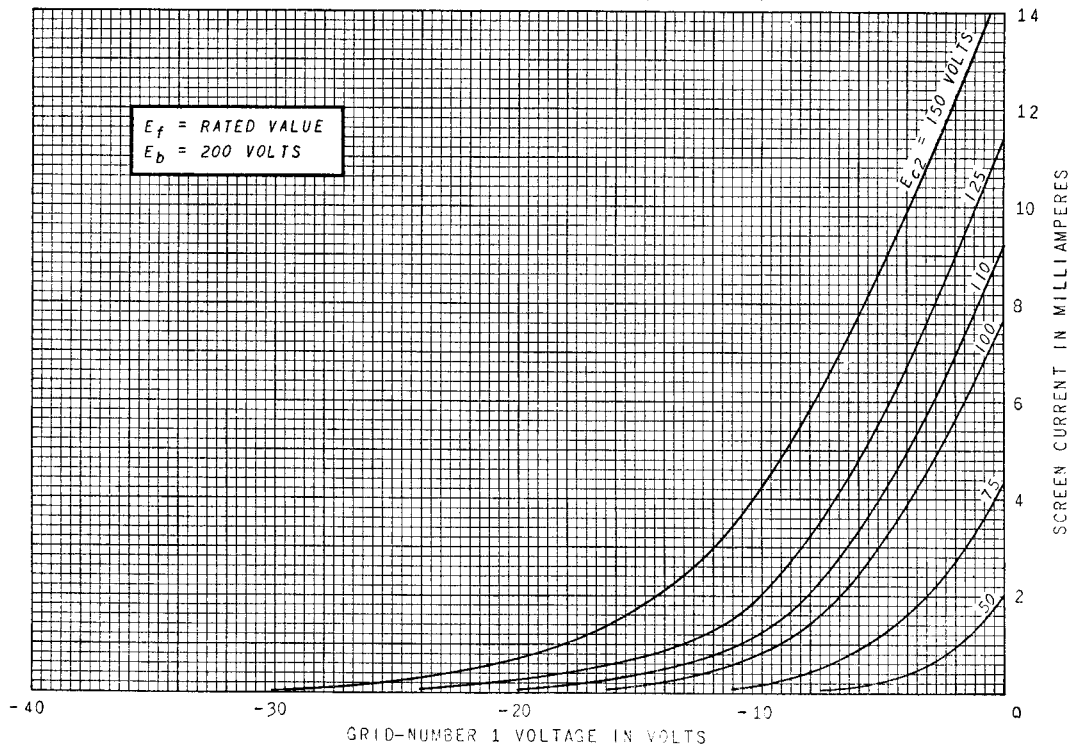

ELECTRONIC COMPONENTS DIVISION



Schenectady 5, N. Y.